

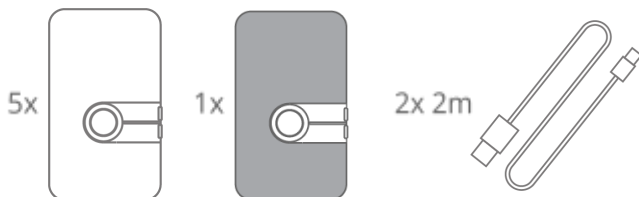

Kit Overview

The UDK1 (Ultra-Wideband Demo Kit) is an all-in-one demonstration ready-to-use kit. The kit provides a wide range of evaluation demonstrations of the Ultra-Wideband technology ranging from Nearby Interaction demo with an iPhone, FiRa compatible Two-Way Ranging with Angle-of-Arrival capabilities, infrastructure-less proximity between the tags, advanced navigation and tracking RTLS (Real-Time Location System) demonstrations using DL-TDoA (Downlink TDoA), UL-TDoA (Uplink TDoA) and TWR (Two-Way Ranging) techniques. Uplink and Downlink data telemetry are also a part of the RTLS demo.

Kit Content



- The kit consists of 6 hardware devices - one LC13 device with an integrated UWB AoA antenna and five LC14 devices with an integrated UWB non-AoA

antenna. All devices can be configured in any mode of the demo including Anchor, Tag, Gateway, FiRa or Nearby Interaction.

- Qorvo [QM33120](#), an Ultra-Wideband FiRa compatible chipset, is integrated together with the popular Bluetooth-capable MCU nRF52840 inside a [Murata 2AB](#) SIP module. With the external LNA/PA, the devices provide superior UWB range coverage.
- They are pre-programmed with LEAPS Ultra-Wideband Subsystem, an all-in-one advanced and versatile software stack that includes Qorvo's FiRa capable software library. Together with a set of tools, it forms a production-ready LEAPS RTLS.
- The kit includes two USB-C data cables for programming, data exchange and powering.
- A battery is not included.
- Free software configuration and visualization tools (software support for iOS, Android, Windows, MacOS and Linux platforms depending on the demo).
- An open online documentation and community forum.
- An open SDK based on Zephyr RTOS for starting development of custom applications.

Typical Applications

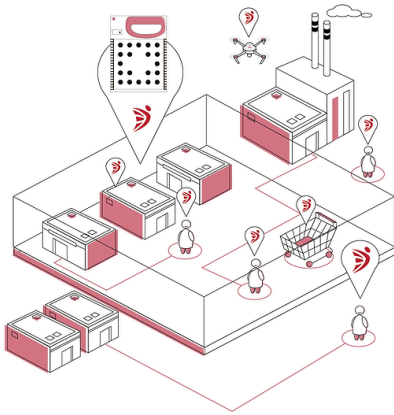

The Ultra-Wideband technology can enable a wide range of applications, with some typical applications listed below.

SMART CITIES & MOBILITY

- Indoor Navigation
- Driverless Valet Parking and Pick-Up
- Parking Garage Access Control

SMART BUILDING & INDUSTRIAL

- Social Distancing
- Indoor Navigation
- Employee Gathering in Emergencies
- Asset Tracking
- Find Equipment
- Patient Tracking
- Proximity-Based Patient Data Sharing

SMART RETAIL

- Foot Traffic and Shopping Behavior Analytics
- Exhibition Attendee Management

SMART HOME & CONSUMER

- Point and Trigger Controller Application
- Residential Access Control
- Easy (Logical) Access to Personal Devices
- Find Someone/Something Nearby
- Presence-Based Device Activation

Demo capabilities of the Kit

The kit offers a platform for demonstrating and evaluating the capabilities of Ultra-Wideband technology in various scenarios.

Nearby Interaction Demo with an iPhone

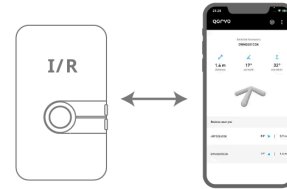

Prepare for setup (FiRa compatible)

- An iPhone device with U1 chip compatibility.
- Qorvo Nearby Interaction application installed from the App Store.
- One or more Nodes (white device) configured in Nearby Interaction mode.

Demonstration

- Demonstrates Nearby Interaction and FiRa compatibility with a smartphone.
- Accurate distance and angle measurement, displaying precise direction to the Node within the smartphone application.
- Typical applications: find my things, follow me, smart remote control, access control.

Locate Device Using Angle-of-Arrival Demo

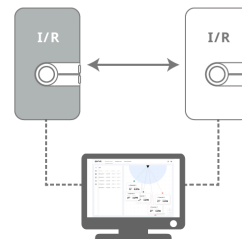

Prepare for setup (FiRa compatible)

- A desktop with Qorvo UWB Ranging & AoA Demo App installed.
- One Node with an AoA antenna (gray device) and one or more Nodes without an AoA antenna (white device) configured in UCI mode.
- Two or more USB cables to connect the Nodes to the PC.

Demonstration

- Demonstrates FiRa compatibility between devices.
- Distance and angle measurement showing the direction between the Initiator and the Responder devices in the desktop application.
- Typical applications: Access control, follow me, locate and track objects or devices within an indoor environment.

Infrastructure-less Proximity Demo

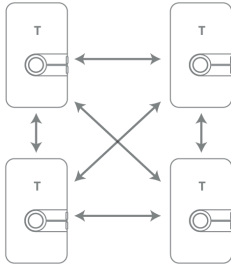

Prepare for setup

- Two or more Nodes configured as Tags.

Demonstration

- Demonstrates infrastructure-less proximity between the Nodes.
- TWR distance measurement between a Node and all its surrounding nodes.
- Trigger alarm using LED, haptic motor or buzzer when Nodes are in close proximity. The distance threshold is configurable.
- Typical applications: Collision avoidance, social distancing, swarm coordination.

Downlink TDoA RTLS Demo

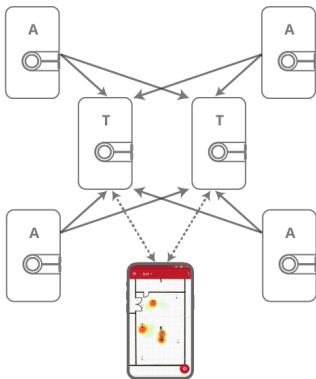

Prepare for setup

- Four Nodes configured as Anchors with fixed positions, and one or more Tag nodes configured as the DL-TDoA mode.
- An Android device with LEAPS Manager application installed and/or a terminal application on the desktop to display the location.

Demonstration

- Demonstrates real-time navigation of an unlimited amount of Tags in receive-only mode with complete privacy using DL-TDoA technology.
- Demonstrates the LEAPS Manager application with Tag position navigation.
- Typical applications: Indoor navigation with mapping, autonomous robot and vehicle navigation, asset tracking with location data being sent through another communication channel.

Uplink TDoA RTLS Demo

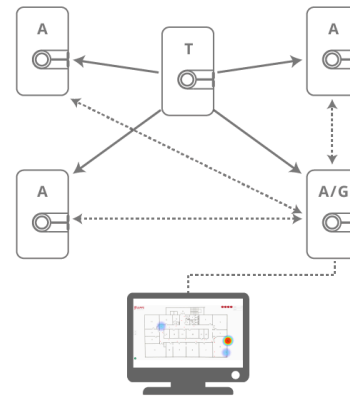

Prepare for setup

- Four Nodes configured as Anchors with fixed positions, one or more Tag nodes configured as the UL-TDoA mode.
- A desktop with LEAPS server software installed for position calculation and visualization.

Demonstration

- Demonstrates real-time tracking of the Tag with high accuracy using UL-TDoA technology.
- Typical applications: Asset and people tracking.

TWR RTLS and Data Telemetry Demo

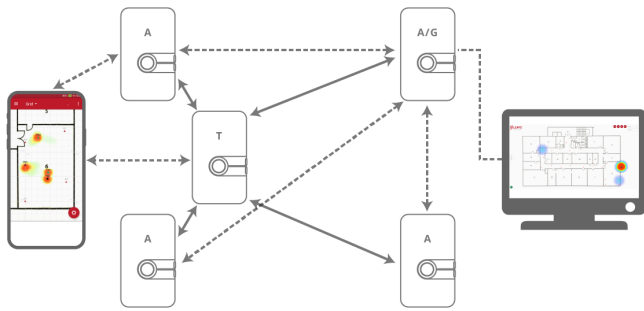

Prepare for setup

- Four Nodes configured as Anchors with fixed position, and one or more nodes configured as TWR and/or DL-TDoA Tag.
- An Android device with LEAPS Manager application installed and/or a terminal application on the desktop to display the location.
- A desktop with LEAPS server software installed for position and data collection and visualization.

Demonstration

- Demonstrates real-time navigation, tracking and both ways of data telemetry using TWR technology.
- Demonstrates real-time navigation of an unlimited amount of Tags using DL-TDoA technology.
- Typical applications: Indoor navigation, asset tracking and real-time data telemetry supporting uplink and downlink.

Development Tools

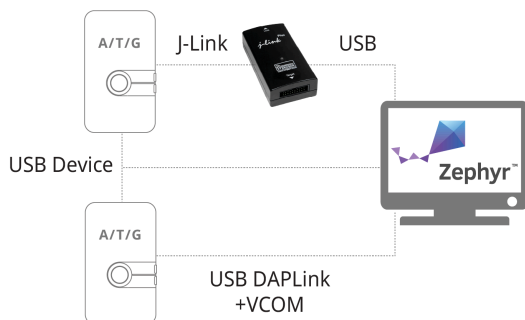

The UDK1 kit is an open platform with an open-source SDK that can facilitate evaluation of the technology and the development of custom applications. The SDK includes device BSPs (Board Support Package),

drivers, IO examples and low-level Ultra-Wideband examples provided by Qorvo. The system is based on the powerful Zephyr RTOS.

Each device embeds a DAPLink accessible via the USB C connector. Alternatively, the user can use an external J-Link debugger via an on-board 6-pin Tag Connect compatible connector.

UDK1 Quick Start Guide

Please visit the [UDK1 Quick Start Guide](#) for more details.



LEAPS RTLS Features

In addition to the specific features of the UDK1 kit, this section provides an overview of the LEAPS RTLS system from a broader perspective.

Key Features

The LEAPS RTLS system provides an advanced and comprehensive solution for real-time accurate positioning and data telemetry using Ultra-Wideband wireless technology. The core of the solution is the highly sophisticated embedded software stack called LEAPS UWBS (Ultra-Wideband Sub-system) that offers many advanced features, including:

- A great versatility in a small footprint makes LEAPS a unique Swiss Army knife for accurate positioning and data telemetry in real-time. The UWB Sub-system is based on one firmware and is configurable in different modes and networking profiles.
- Highly embedded, effective, optimized stack focusing on versatility, high performance, low memory, and low power consumption.
- Proven system scalability deployed in various large-scale plants and buildings with an operational range of 50,000+ m².
- A modular structure facilitates adding new features and support for new hardware, which currently supports over 15 distinct board types and variants.
- Currently, it is available on various hardware platforms, including [Murata_2AB](#), [DWM3001C](#), [DWM1001C](#), Ambiq Micro MCU and Linux Driver.
- An extensive API allows users to easily configure and customize the system according to their specific needs, providing a highly adaptable and versatile solution for real-time location tracking. The application can use binary Type-Length-Value (TLV) frame format via various interfaces like UART, USB, SPI, BLE or human readable shell command line over UART, USB and BLE interfaces.
- The LEAPS RTLS system also provides an extensive range of free software tools that allow easy configuration and management of the system.

- A continuous development of the LEAPS RTLS will provide more features to cover a wider range of applications in the future. This allows the users and product builders to learn one concept and deploy in many applications.

Performance

- The networking stack is designed in the way that it always aims to reuse the air-time using an effective mechanism for both Anchors and Tags. This allows a virtually unlimited amount of nodes to be deployed in a spread area. All of this happens automatically using effective mechanisms of Anchors Auto-Clustering and Tags Roaming.
- Depending on the measurement mode of the Tags, the maximum density can be 320 Hz for the TWR, 600 Hz for the UL-TDoA or an unlimited amount of Tags when DL-TDoA is used. The maximum density is achieved under specific conditions, when all the Tags are in range with each other, then there can be e.g. 3200 Tags with an update rate 0.1Hz, 320 Tags @ 1Hz or 32 Tags @ 10 Hz. The Tags would function with zero or minimum interference with each other.
- Maximum tag location rate: Depending on network profile and measurement mode. Typically, 10 Hz for TWR, DL-TDoA and UL-TDoA. DL-TDoA can provide up to 50 Hz update rate per Tag.
- X-Y location accuracy: Better than 50 cm, typically 10 cm.
- Point-to-point range: Up to 50 m in Line-of-Sight conditions (CH5/CH9), up-to 150 m when PA is used.
- Infrastructure deployment grid size: Typically, 20 x 20m and can work up-to 40 x 40m.
- Superior power management provides a long battery lifetime for TWR and TDoA modes.
- Adaptive location rate using motion sensor activity enables a longer battery lifetime and a higher total amount of Tags.

System Architecture Overview

This section provides a more detailed understanding of the LEAPS RTLS system and outlines its specific components, which are further elaborated in the following subsections.

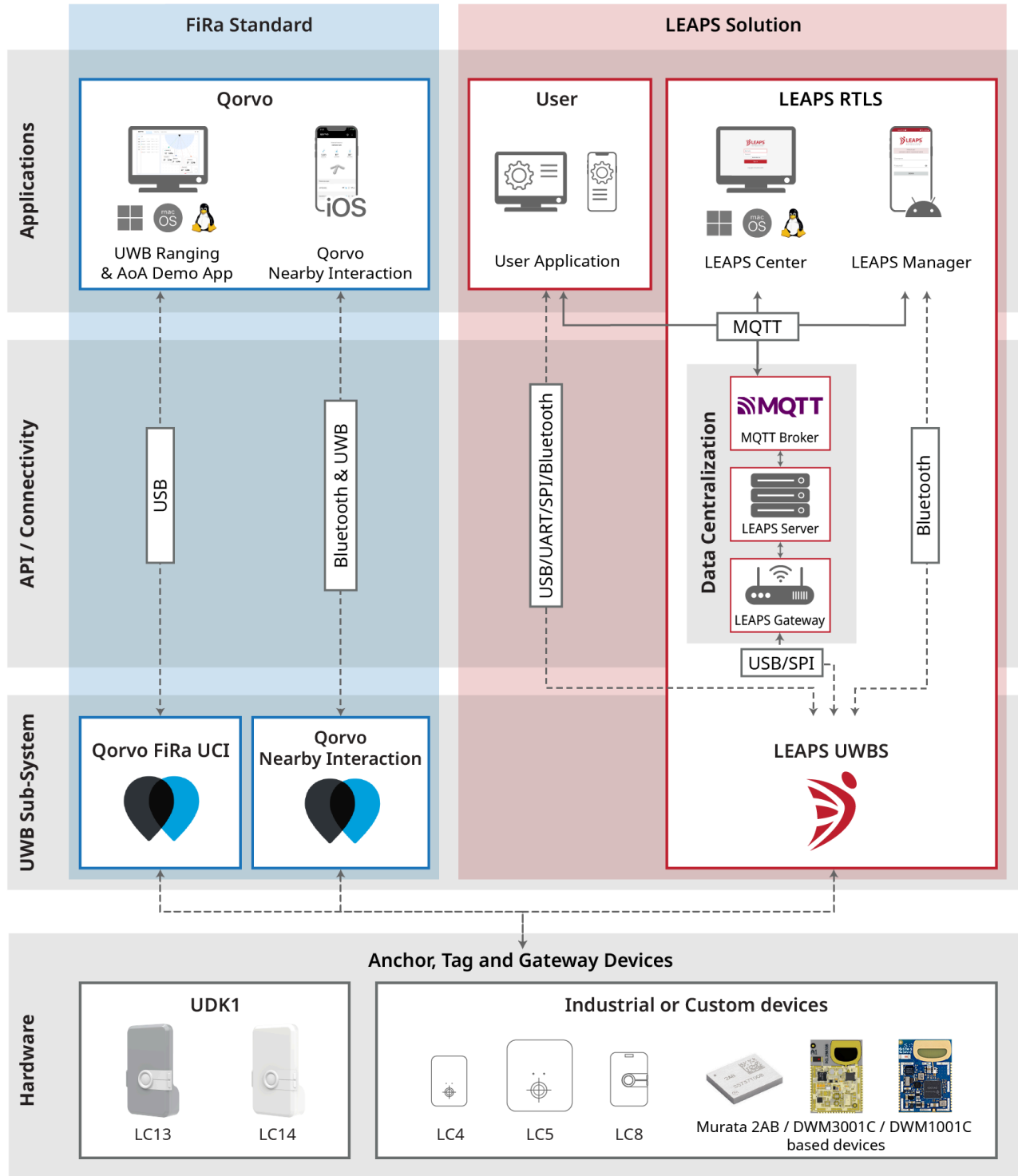

LEAPS UWBS

LEAPS UWBS is a fully-embedded and advanced UWB Sub-System that covers a wide range of use cases. One UWB Sub-System is configurable in different modes and profiles. The UWBS can run as an Anchor, a Tag or a Gateway. The networking profiles are fully scalable with high capacity and low power.



- Versatility makes it easy to balance the system requirements, costs, deployment time and maintenance complexity. Applications range from simple distance proximity, to high speed tracking or navigation of unlimited receivers.
- It integrates a sophisticated UWBMAC that allows adaptive clustering of the infrastructure devices, air-time reuse, slot allocation, etc. A scalable, proven collision detection, collision avoidance, and collision resolution allow the system to function robustly in complex environments.
- Supported measurement techniques include TWR, DL-TDoA and UL-TDoA. Integrated location engines allow the device to operate independently in the navigation mode using DL-TDoA or TWR.
- Superior power management provides a long battery lifetime for TWR and TDoA modes.

LEAPS API

- The LEAPS RTLS software stack provides a range of advanced and open APIs that allow easy configuration of the device to suit custom applications. It provides users with flexibility to tailor the system to their specific needs.
- It utilizes the binary Type-Length-Value (TLV) frame format, making it

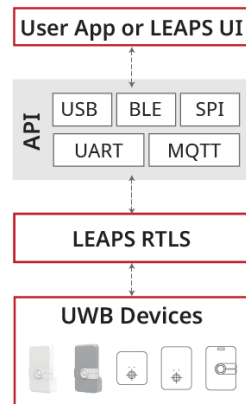

easier for external devices via UART, USB, SPI and BLE interfaces. When data centralization is used, the communication via MQTT using JSON is available for the high-level applications.

- A command line is supported through the UART, USB and BLE interfaces with more user-friendly and readable text.

LEAPS Manager

LEAPS Manager is an Android application that provides device discovery, device configuration, network configuration, network management and location visualization.



LEAPS Manager

- The Demo Wizard allows an easy and super fast way to configure predefined demo setups of the kit.
- The Grid in 2D and 3D provides real-time position updates and visualization of the devices in the network.
- The communication with the devices is done via the BLE with support for up to 6 concurrent connections to maintain connection reliability.
- When data centralization is used, communication with the LEAPS Server via MQTT is available, allowing management and visualization of the devices for the whole network.
- Other useful features include User Management, Firmware Update over BLE, Anchors Auto-Positioning, Position Logging and Debug Console.

LEAPS Gateway

LEAPS Gateway serves as a bridge between the UWB and the TCP/IP networks.



LEAPS Gateway

- The LEAPS Gateway communicates on one side with the LEAPS UWBS via the generic LEAPS API, SPI or USB, and on the other side with the LEAPS Server via the TCP/IP.

- Depending on the LEAPS UWB networking profile, it provides a medium for transferring uplink and downlink location and telemetry data of the Anchors and Tags to and from the MQTT Broker.
- The interconnection with the UWBS is done via the SPI on a dedicated LEAPS Gateway embedded device. When the interconnection with the LEAPS UWBS is done via the USB, like in the case of the UDK1 devices, LEAPS Gateway runs on a Linux platform as a daemon service.
- The Grid in 2D and 3D provides real-time position updates and visualization of the devices in the network.
- Other useful features include User Management, Zone Management, Zone History, Floorplan Management, Position History and Position Heatmap.
- The LEAPS Center interconnects with the LEAPS Server via the MQTT Broker. It runs as a service on Linux and Windows platforms.

LEAPS Server

LEAPS Server is a central data hub for the UWB network. It interconnects all the LEAPS Gateway devices with the world via a MQTT Broker.

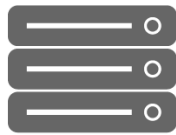

LEAPS Server

- It functions as an uplink data concentrator, downlink data router, data processor, location engine, device management, device access control and quality of service.
- It communicates with the world via the connectors. Currently, the supported connector is MQTT, which includes support for AWS.
- The LEAPS Server runs as a daemon service on the Linux platform.

MQTT Broker

An MQTT broker is a server that receives all messages from the clients and then routes the messages to the appropriate destination clients. An MQTT client is any device (from a micro controller up to a fully-fledged server) running an MQTT library and connecting to an MQTT broker over a network.



MQTT Broker

LEAPS Center

LEAPS Center is a web application that provides device management, network management and visualization of location and telemetry data for the whole network.



LEAPS Center

LC13 and LC14 Specifications

This section provides technical details of the LC13 and LC14 devices. The LC13/LC14 devices can be used to create an Anchor Node (AN), Anchor Initiator Node (ANI), Tag Node (TN) and Gateway for a Real-Time Location System (RTLS). It is also compatible with FiRa Nearby Interaction and Two-Way Ranging Angle-of-Arrival (TWR-AoA) demo. Furthermore, this open platform can be used for developing UWB or Bluetooth applications.

Key Features

- Based on [Murata 2AB](#) SIP (MCU nRF52840 with Bluetooth, UWB [QM33120W](#) IC, LIS2DW accelerometer, crystals and internal power regulators).
- Qorvo QM33120W - Ultra Wideband (UWB):
 - Based on the IEEE802.15.4z standard and implements enhanced security features.
 - Supports both channel 5 (6.5 GHz) and channel 9 (8 GHz) with UWB RF compliance compatible with FCC, Japan's ARIB, ETSI and +10dB ETSI of the CE.
 - Integrates Low Noise Amplifier (LNA) and Power Amplifier (PA) to increase the UWB range (up to 150m).
 - With integrated non-AoA (LC14) and AoA antennas (LC13).
 - FiRa™ PHY and MAC compatible. Interoperable with the Apple U1 chip and Android FiRa compatible smart devices.
 - Backward compatibility with DW1000 IEEE802.15.4a UWB IC on channel 5.

- Supports Two-Way Ranging (TWR), Time Difference of Arrival (TDoA) and Phase Difference of Arrival (PDoA).
- Nordic Semiconductor nRF52840 - Bluetooth® Low-Energy (BLE) 5.3 RF Technology with an integrated antenna.
- Supports NFC tag antenna connector.
- 2 USB C ports integrate a DAPLink programmer with Virtual COM and a USB device interface for data communication.
- Alternatively, J-Link can be used via an onboard 6-pin Tag Connect compatible connector.
- It contains RGB LEDs, 2x GREEN LEDs, a front button, two side buttons, a USB connector for a nRF52 USB device, a buzzer, a haptic motor and extra GPIOs for connection with external sensors or IOs.

Software Compatibility

It is compatible with LEAPS UWBS, Qorvo FiRa compatible UWBS (Nearby Interaction, TWR AoA), PANS PRO UWBS and third-party stack (open platform). The default firmware is LEAPS UWBS with Qorvo FiRa compatible demos supplied from the production.

Electrical Parameters

Parameter	Value
Battery power supply	+3.7V (Fenix RCR123A is recommended) Current consumption: 270 uA @ 3.7V in deep sleep 24 uA @ 3.7V in deep sleep with SWD_DIO jumper disconnected
USB C (power and data)	5V @ 500mA max
Operating temperature (without battery)	-40°C - +85°C
Operating temperature (with battery)	-20°C - +45°C
UWB supported channels	Channel 5 (6240–6739.2 MHz, CF=6489.6 MHz) Channel 9 (7738–8237.2 MHz, CF=7987.2 MHz, FiRa compatible)

UWB transmit powers	FCC/ARIB/ETSI: -41.3 dBm/MHz max ETSI (+10 dB): -31.3 dBm/MHz max
Target Accuracy	Ranging accuracy: +/- 9 [cm] PDoA accuracy: +/- 5 [deg] AoA accuracy: +/- 2.5 [deg]

Mechanical Parameters

Parameter	Value
Size	W=72 x H=120 x D=30 mm
Weight	Without battery: 82g With battery: 101g
Color	LC13 - Gray, LC14 - White
Mounting	Compatible with 1/4"-20 screw camera mount

Device Overview

The following pictures give an overview of the main components of the LC13 and LC14 devices.

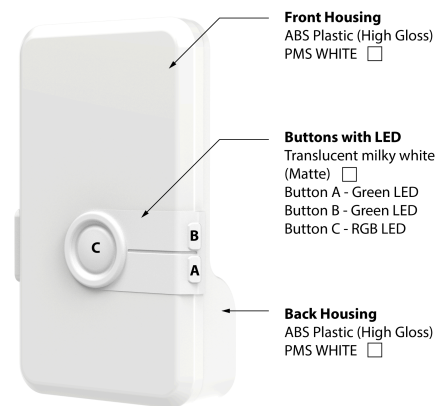

Figure 1: Front view of the LC14 device

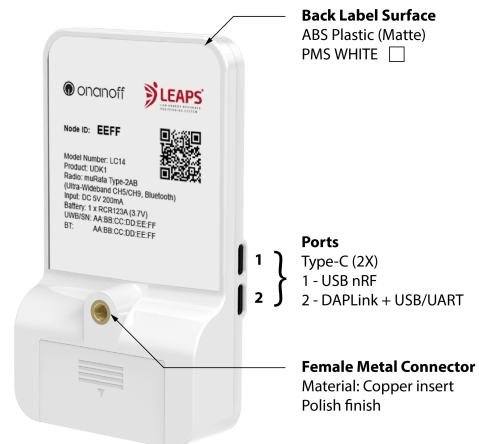

Figure 2: Back view of the LC14 device



Figure 3: Front / Back view of the LC13 device

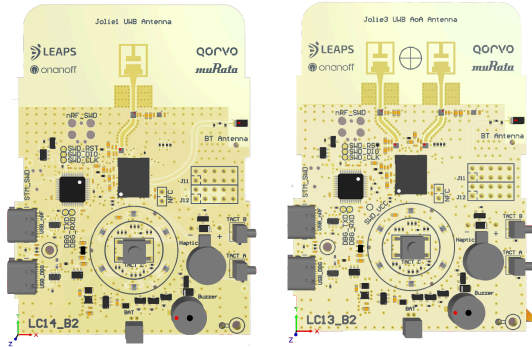

Figure 4: Top view of the board
(Left - LC14, Right - LC13)

Safety Instructions

- Do not expose the device to water or moisture whilst in operation.
- Do not expose the device to heat from any source.
- Take care whilst handling to avoid mechanical or electrical damage to the product.

Warnings

- This device should only be connected to an external power supply rated at 5V/0.5A DC or a 3.7V battery.
- Replacement of a battery with an incorrect type can defeat a safeguard (for example, in the case of some lithium battery types).
- Disposal of a battery into fire or a hot oven, or mechanically crushing or cutting of a battery, which can result in an explosion.
- Leaving a battery in an extremely high temperature surrounding environment can result in an explosion or the leakage of flammable liquid or gas.

- A battery subjected to extremely low air pressure may result in an explosion or the leakage of flammable liquid or gas.

Important Notice

- The hardware and software of the kit are intended for demonstration purposes only. To obtain an industrial-grade system, please kindly contact us to discuss the specific needs and requirements.
- For more detailed information on Qorvo software tools, such as Qorvo's FiRa compatible stack, Qorvo Nearby Interaction and UWB Ranging & AoA Demo Application, please refer to the appropriate documentation or resources that are available at [Qorvo's website](https://www.qorvo.com).

Order Information

- Part number: UDK1
- Custom code: HS 8517.69.9000



About Us

Onanoff and LEAPS are teams of experienced product designers and manufacturers focusing strongly on UWB technology. We offer OEM/ODM services, engineering design and support cooperation. Our team is passionate about conceiving, tooling, and manufacturing products that meet your design specifications.

Contact Us

Onanoff Limited
 Room 424, Sino Industrial Plaza
 9 Kai Cheung Rd
 Kowloon Bay
 Hong Kong
 Phone: +852 23930306
 Web: <https://www.onanoff.com>
 E-mail: sales@onanoff.com

LEAPS s.r.o.
 Hodoninska 1,
 141 00
 Prague 4
 Czech Republic, EU
 Phone: +420 222 966 953
 Web: <https://www.leapslabs.com>
 E-mail: sales@leapslabs.com